

20M 30M 40M 50M

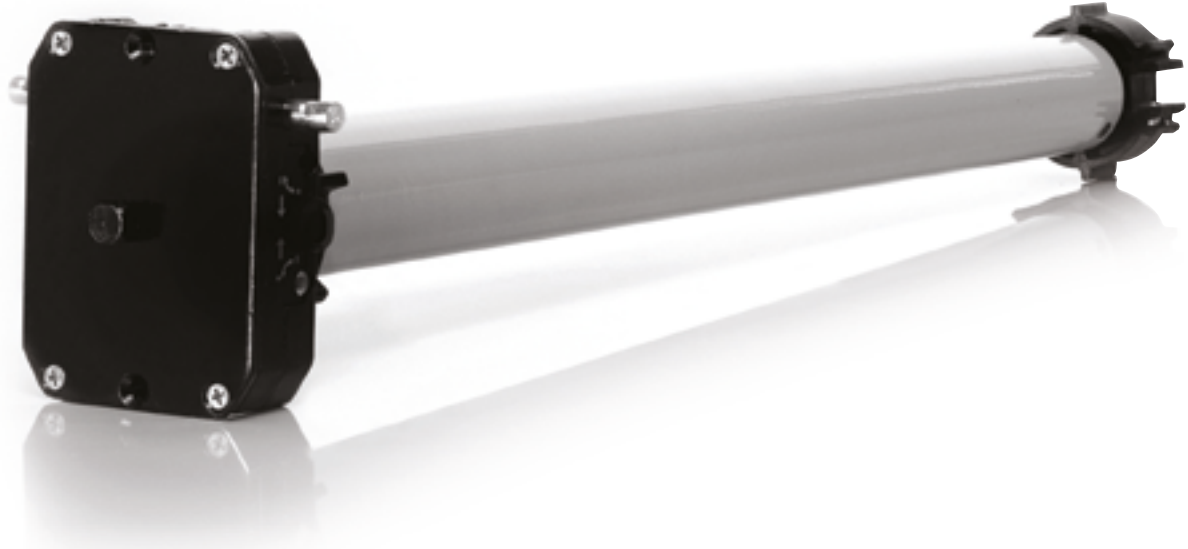

P-850MRC20M

230 V Tubular motor, hand crank function, Ø 45 mm, c/w bracket and adapters for tube Ø 70 mm 20 N m torque.

P-850MRC30M

230 V Tubular motor, hand crank function, Ø 45 mm, c/w bracket and adapters for tube Ø 70 mm 30 N m torque.

P-850MRC40M

230 V Tubular motor, hand crank function, Ø 45 mm, c/w bracket and adapters for tube Ø 70 mm 40 N m torque.

P-850MRC50M

230 V Tubular motor, hand crank function, Ø 45 mm, c/w bracket and adapters for tube Ø 70 mm 50 N m torque.

Application chart for awnings

ARM WITH 15 kg POWER

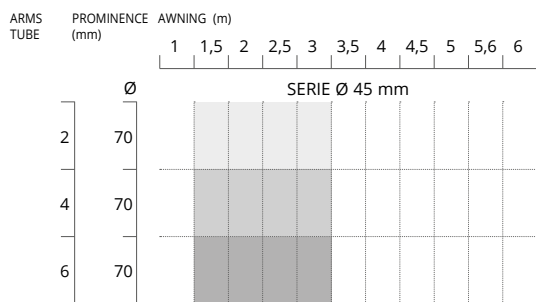

ARM WITH 25 kg POWER

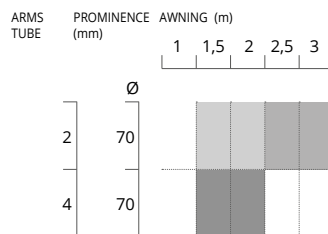

ARM WITH 35 kg POWER

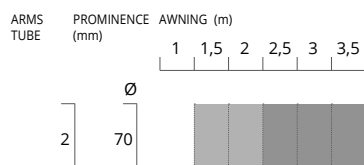

ARM WITH 45 kg POWER

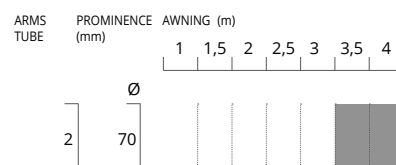

References

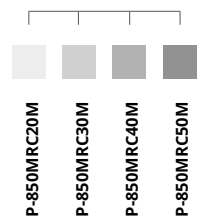



MADE IN ITALY

FEATURES:

- tubular motor \varnothing 45 mm
- 230 V motor
- built-in hand crank function
- self-braking motor
- max. run time 4'

PROS:

- ideal for awnings' projection up to 4 m
- quick installation
- easy setting of limit switches
- emergency manual operation thanks to the optional hand crank
- easy limit switches setting

Technical features	MRC20M	MRC30M	MRC40M	MRC50M
Degree of protection	IP 44			
Power supply	230 V AC (50 - 60 Hz)			
Absorption	0,92 A	1,1 A	1,3 A	1,4 A
Absorbed power	205 W	230 W	292 W	308 W
Crown Speed	13 rpm	13 rpm	13 rpm	13 rpm
Lifting Power	38 kg	56 kg	76 kg	94 kg
Operating temperature	-10° C ÷ +60° C			
Operating time	4 min			
Torque	20 N m	30 N m	40 N m	50 N m

DISEGNI TECNICI

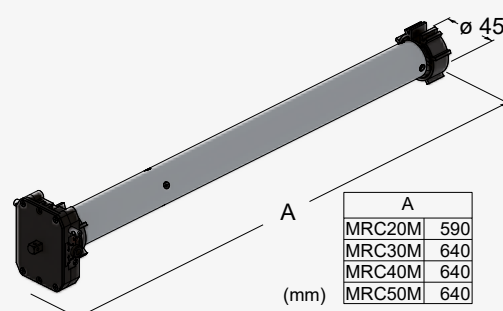

ACCESSORIES



P-850AD70C
Replacement crown drive adapter kit for tube \varnothing 70 mm



P-850CSV
Sun-wind-rain control unit for 1 motor, to be combined with P-850ANCP



P-850SND45C
45°/90° hand crank loop for shutter box



P-850ANCP
Sensor of light and wind detection



P-850DZ68
45°/90° hand crank loop for shutter box



P-850PLV
Rain sensor



P-850MAN150
Steel hand crank, 1500 mm, with joint arm



P-850OCC
Hand crank loop